

CoroMill® 210

Hoge voedings vlak- en plungefreesen

Toepassing

- Vlakfreesen met hoge voeding
- Axiaal frezen
- Infrezen
- Voorfrezen tot semi-nafrezen
- Helicoidaal frezen
- Profielrezen

ISO toepassingsgebied:



Voordelen en kenmerken

- Hoge tafelvoeding dankzij spaan"verdunningseffect" – hoge productiviteit
- Eerste keuze vlakfrees bij het bewerken met lange uitsteeklengtes
- Multifunctioneel gereedschap. Vlakfreesen, kottermogelijkheden, infrezen en plungefreesen
- Inwendig koelmiddel

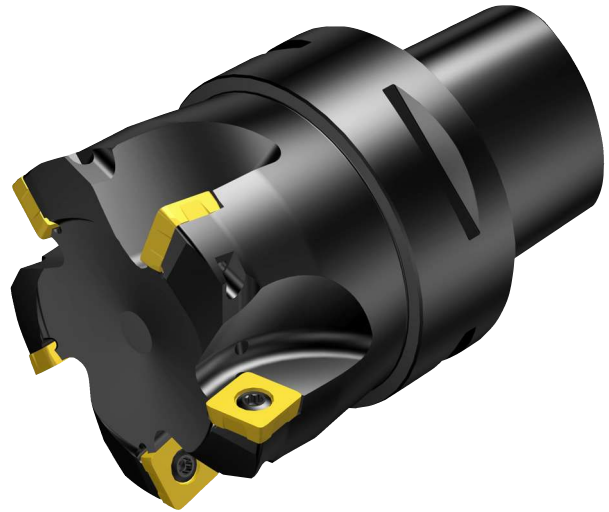

www.sandvik.coromant.com/coromill210

Koppelingen

- Coromant Capto®
- Doorn
- Cilindrische schacht
- Draadkoppeling

Wisselplaten

- Vier snijkanten
- Wisselplaatgeometrieën en hardmetaalsoorten voor alle materialen, behalve ISO N
- E-xM geometrie voor uitstekende prestaties in titanium

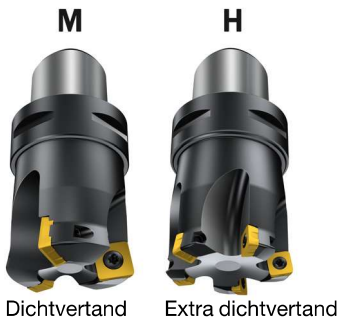

Dichtvertand

Extra dichtvertand

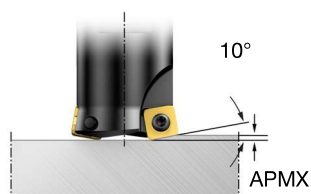

De 10° instelhoek maakt extreme voedingen mogelijk bij het vlakfreesen.

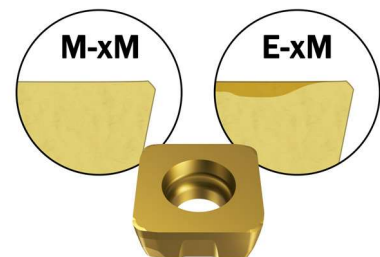

Aanbevolen voeding per tand (fz) 1,5 mm voor wisselplaatgrootte 09 en 2 mm per tand (fz) voor wisselplaatgrootte 14.



I33



I36

CoroMill® 210 vlakfrees

Coromant Capto® - inwendige koelmiddeltoevoer

Hoge voedingsfrees

KAPR

10°

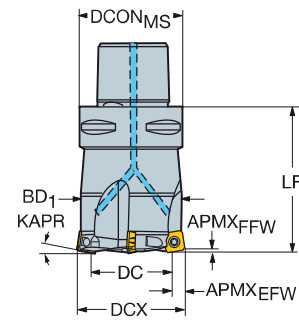
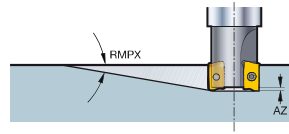

											Afmetingen, mm								
DC		CZC _{MS}	APM _{EFW}	APM _{FFW}	RMPX	AZ	CNSC		Bestelnummer	DCON _{MS}	DCX	BD	LF			RPMX	CICT	MIID	
21.9	09	C3	8.0	1.20	7°	1.8	3	2	R210-036C3-09M	32.0	36.0	33.0	50.0	3.0	0.44	30900	2	R210-090412M-	
	09	C3	8.0	1.20	7°	1.8	3	3	R210-036C3-09H	32.0	36.0	33.0	50.0	3.0	0.37	30900	3	R210-090412M-	
27.9	09	C4	8.0	1.20	5°	1.8	3	3	R210-042C4-09M	40.0	42.0	39.0	60.0	3.0	0.79	27600	3	R210-090412M-	
	09	C4	8.0	1.20	5°	1.8	3	4	R210-042C4-09H	40.0	42.0	39.0	60.0	3.0	0.60	27600	4	R210-090412M-	
28.0	14	C5	13.0	2.00	5°	2.0	3	3	R210-052C5-14M	50.0	52.0	47.7	70.0	5.0	1.21	20800	3	R210-140512M-	
	14	C5	13.0	2.00	3°	2.0	3	4	R210-052C5-14H	50.0	52.0	47.7	70.0	5.0	1.21	20800	4	R210-140512M-	
30.0	14	C5	13.0	2.00	5°	2.0	3	4	R210-054C5-14H	50.0	54.0	49.7	70.0	5.0	1.35	23600	4	R210-140512M-	
37.9	09	C5	8.0	1.20	3°	1.8	3	4	R210-052C5-09M	50.0	52.0	49.0	70.0	3.0	1.26	24000	4	R210-090412M-	
	09	C5	8.0	1.20	3°	1.8	3	5	R210-052C5-09H	50.0	52.0	49.0	70.0	3.0	1.20	24000	5	R210-090412M-	
39.9	09	C5	8.0	1.20	3°	1.8	3	5	R210-054C5-09H	50.0	54.0	51.0	70.0	3.0	1.15	23600	5	R210-090412M-	
42.0	14	C6	13.0	2.00	3°	2.0	3	4	R210-066C6-14M	63.0	66.0	61.7	72.0	5.0	2.02	17700	4	R210-140512M-	
	14	C6	13.0	2.00	3°	2.0	3	5	R210-066C6-14H	63.0	66.0	61.7	72.0	5.0	2.03	17700	5	R210-140512M-	
51.9	09	C6	8.0	1.20	2°	1.8	3	6	R210-066C6-09M	63.0	66.0	63.0	72.0	3.0	2.05	21300	6	R210-090412M-	
58.0	14	C8	13.0	2.00	2°	2.0	3	5	R210-082C8-14M	80.0	82.0	77.7	80.0	5.0	3.50	15100	5	R210-140512M-	
	14	C8	13.0	2.00	2°	2.0	3	6	R210-082C8-14H	80.0	82.0	77.7	80.0	5.0	3.46	15100	6	R210-140512M-	
62.0	14	C8	13.0	2.00	2°	2.0	3	6	R210-086C8-14H	80.0	86.0	81.7	80.0	5.0	3.67	14700	6	R210-140512M-	

	Reserve onderdelen
	Wisselplaat-schroef
09	5513 020-02
14	5513 020-50

Ga voor de complete lijst van reserveonderdelen naar www.sandvik.coromant.com



I36



L2



N23



N9



N15

CoroMill® 210 vlakfrees

Doornbevestiging - inwendige koelvloeïstoftoevoer

Hoge voedingsfreesen

STDNO
KAPR

ISO6462
10°

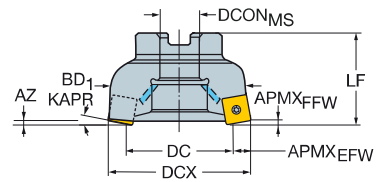
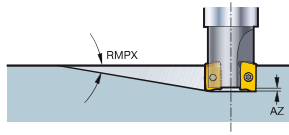

										Afmetingen, mm									
DC	CZC _{MS}	APMX _{FFW}	APMX _{EFW}	RMPX	AZ	CNSC	Bestelnummer		DCON _{MS}	ISO	DCX	BD	LF	NM	KG	RPMX	CICT	MID	
35.9	09	22	8.0	1.20	3°	1.8	1	4	R210-050Q22-09M	22.0	A	50.0	47.0	50.0	3.0	0.43	24500	4	R210-090412M-
	09	22	8.0	1.20	3°	1.8	1	5	R210-050Q22-09H	22.0	A	50.0	47.0	50.0	3.0	0.63	24500	5	R210-090412M-
39.0	14	22	13.0	2.00	3°	2.0	1	4	R210-063Q22-14M	22.0	A	63.0	58.7	50.0	5.0	0.76	18300	4	R210-140512M-
	14	27	13.0	2.00	3°	2.0	1	4	R210-063Q27-14M	27.0	A	63.0	58.7	50.0	5.0	0.81	18300	4	R210-140512M-
	14	22	13.0	2.00	3°	2.0	1	5	R210-063Q22-14H	22.0	A	63.0	58.7	50.0	5.0	0.50	18300	5	R210-140512M-
48.9	09	22	8.0	1.20	2°	1.8	1	5	R210-063Q22-09M	22.0	A	63.0	60.0	50.0	3.0	0.85	21800	5	R210-090412M-
	09	27	8.0	1.20	2°	1.8	1	5	R210-063Q27-09M	27.0	A	63.0	60.0	50.0	3.0	1.05	21800	5	R210-090412M-
	09	22	8.0	1.20	2°	1.8	1	6	R210-063Q22-09H	22.0	A	63.0	60.0	50.0	3.0	0.81	21800	6	R210-090412M-
56.0	14	27	13.0	2.00	2°	2.0	1	5	R210-080Q27-14M	27.0	A	80.0	75.7	50.0	5.0	1.10	15400	5	R210-140512M-
	14	27	13.0	2.00	2°	2.0	1	6	R210-080Q27-14H	27.0	A	80.0	75.7	50.0	5.0	1.20	15400	6	R210-140512M-
76.0	14	32	13.0	2.00	1°	2.0	1	6	R210-100Q32-14M	32.0	B	100.0	95.7	50.0	5.0	1.85	13400	6	R210-140512M-
	14	32	13.0	2.00	1°	2.0	1	7	R210-100Q32-14H	32.0	B	100.0	95.7	50.0	5.0	1.92	13400	7	R210-140512M-
101.0	14	40	13.0	2.00	1°	2.0	1	7	R210-125Q40-14M	40.0	B	125.0	120.7	63.0	5.0	3.83	11400	7	R210-140512M-
136.0	14	40	13.0	2.00	1°	2.0	1	8	R210-160Q40-14M	40.0	B	160.0	155.7	63.0	5.0	5.78	10400	8	R210-140512M-

	Reserve onderdelen
	Wisselplaat-schroef
09	5513 020-02
14	5513 020-50

Ga voor de complete lijst van reserveonderdelen naar www.sandvik.coromant.com



I36



L2



M1



N23



N9



N15

CoroMill® 210 vlakfrees

Cilindrische schacht - interne koelmiddeltoevoer

Hoge voedingsfrees

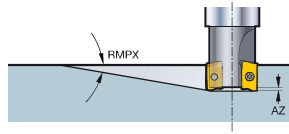

KAPR

10°

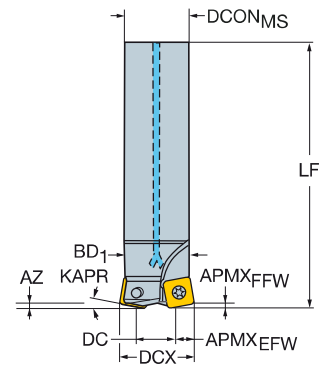

											Afmetingen, mm								
DC	CZC _{MS}	APM _{EFW}	APM _{FFW}	RMPX	AZ	CNSC	Bestelnummer		DCON _{MS}	DCX	BD	LB	LF	NM	KG	RPMX	CICT	MIID	
10.9	09	20	8.0	1.20	14°	1.8	1	2	R210-025A20-09M	20.0	25.0	22.0	35.0	180.0	3.0	0.54	17200	2	R210-090412M-
17.9	09	25	8.0	1.20	8°	1.8	1	2	R210-032A25-09M	25.0	32.0	29.0	45.0	210.0	3.0	0.88	11000	2	R210-090412M-
09	25	8.0	1.20	8°	1.8	1	3	3	R210-032A25-09H	25.0	32.0	29.0	45.0	210.0	3.0	0.50	11000	3	R210-090412M-
20.9	09	32	8.0	1.20	7°	1.8	1	3	R210-035A32-09H	32.0	35.0	32.0	45.0	210.0	3.0	1.30	11000	3	R210-090412M-
27.9	09	32	8.0	1.20	5°	1.8	1	3	R210-042A32-09M	32.0	42.0	39.0	50.0	250.0	3.0	1.83	8000	3	R210-090412M-
09	32	8.0	1.20	5°	1.8	1	4	4	R210-042A32-09H	32.0	42.0	39.0	50.0	250.0	3.0	1.77	8000	4	R210-090412M-

Schroefdraadkoppeling - interne koelmiddeltoevoer

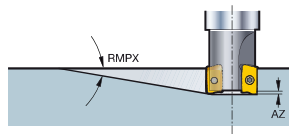

KAPR

10°

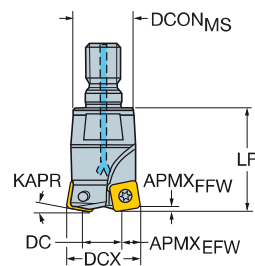

											Afmetingen, mm							
DC	CZC _{MS}	APM _{EFW}	APM _{FFW}	RMPX	AZ	CNSC	Bestelnummer		DCON _{MS}	DCX	BD	LF	NM	KG	RPMX	CICT	MIID	
10.9	09	M12	8.0	1.20	14°	1.8	1	2	R210-025T12-09M	20.8	25.0	22.0	35.0	3.0	0.24	15000	2	R210-090412M-
17.9	09	M16	8.0	1.20	8°	1.8	1	2	R210-032T16-09M	28.8	32.0	29.0	45.0	3.0	0.36	15000	2	R210-090412M-
20.9	09	M16	8.0	1.20	7°	1.8	1	3	R210-035T16-09H	28.8	35.0	32.0	50.0	3.0	0.37	15000	3	R210-090412M-
27.9	09	M16	8.0	1.20	5°	1.8	1	4	R210-042T16-09H	28.8	42.0	39.0	50.0	3.0	0.44	15000	4	R210-090412M-

Reserve onderdelen
Wisselplaat-schroef
5513 020-02

Ga voor de complete lijst van reserveonderdelen naar www.sandvik.coromant.com



I36



L2



N23



N9



N15

CoroMill® 210 freeswisselplaat

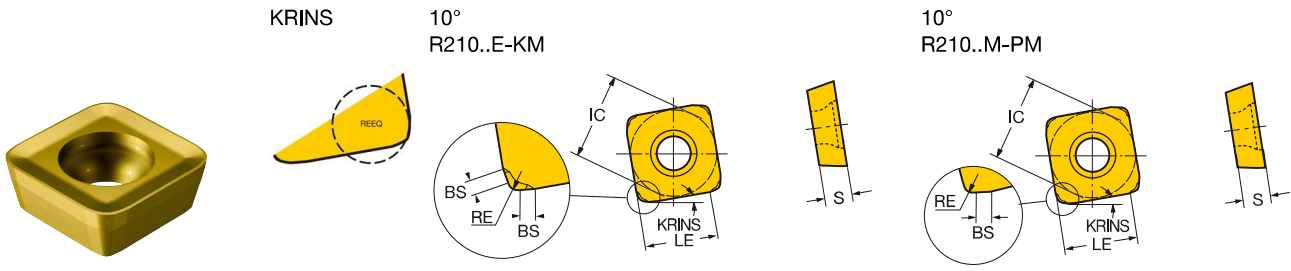

	RE	Bestelnummer	Afmetingen, mm																					
			P			M		K		N		S		H										
			1130	4220	4330	4340	1040	1130	2040	1020	3040	3330	1130	1130	S30T	S40T	1010	1130						
Middelmatig	KM	09 1.00 R210-09 04 12M-KM							☆	☆	☆	☆						9.4	6.2	4.00	0.8	50.0	2.50	
		1.40 R210-09 04 14E-KM							☆	☆	☆	☆						9.5	5.7	4.50	0.7	50.0	2.50	
		14 1.00 R210-14 05 12M-KM								☆	☆	☆	☆						14.5	11.3	4.76	0.8	50.0	3.50
		1.40 R210-14 05 14E-KM								☆	☆	☆	☆						14.6	10.8	5.26	0.7	50.0	3.50
		09 1.00 R210-09 04 12M-MM					☆		☆										9.4	6.2	4.00	0.8	50.0	2.50
		1.40 R210-09 04 14E-MM					☆		☆										9.5	5.7	4.50	0.7	50.0	2.50
	MM	14 1.00 R210-14 05 12M-MM					☆		☆										14.5	11.3	4.76	0.8	50.0	3.50
		1.40 R210-14 05 14E-MM					☆		☆										14.6	10.8	5.26	0.7	50.0	3.50
		09 1.00 R210-09 04 12M-PM	☆	☆	☆	☆				☆	☆	☆	☆	☆	☆	☆	☆		9.4	6.2	4.00	0.8	50.0	2.50
		1.40 R210-09 04 14E-PM	☆	☆	☆	☆				☆	☆	☆	☆	☆	☆	☆	☆		9.5	5.7	4.50	0.7	50.0	2.50
		14 1.00 R210-14 05 12M-PM	☆	☆	☆	☆				☆	☆	☆	☆	☆	☆	☆	☆		14.5	11.3	4.76	0.8	50.0	3.50
		1.40 R210-14 05 14E-PM	☆	☆	☆	☆				☆	☆	☆	☆	☆	☆	☆	☆		14.6	10.8	5.26	0.7	50.0	3.50



I33

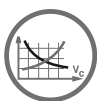

I154



I175



N23



N10